

TRYCKLAGER / THRUST BEARING

art nr./part no. 6039277

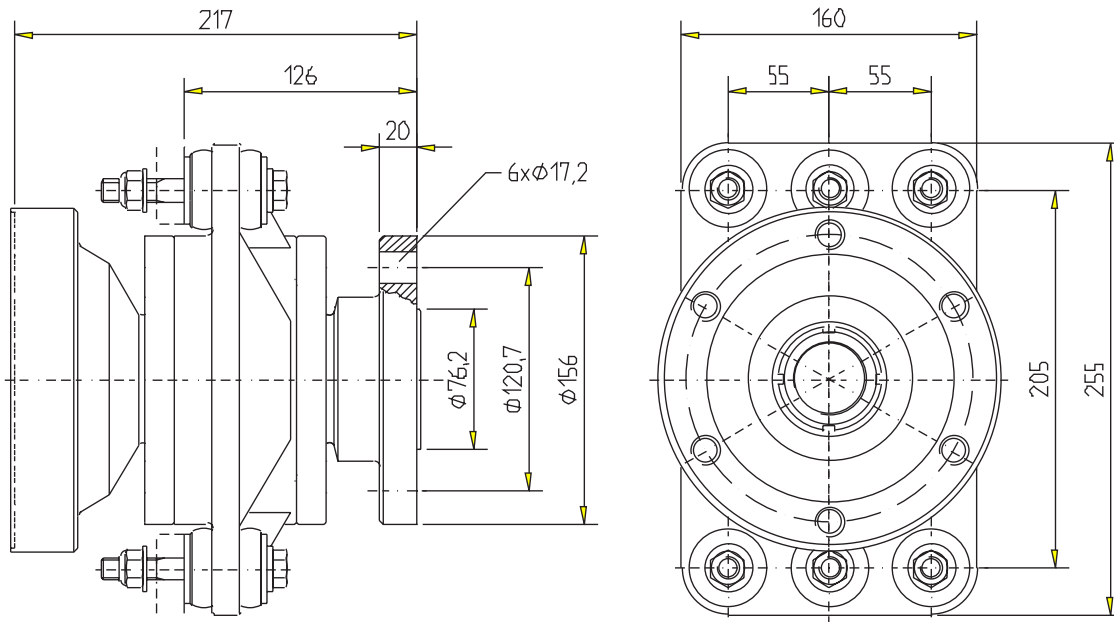

Bearing life L_{10} , Lagerlivslängd L_{10}

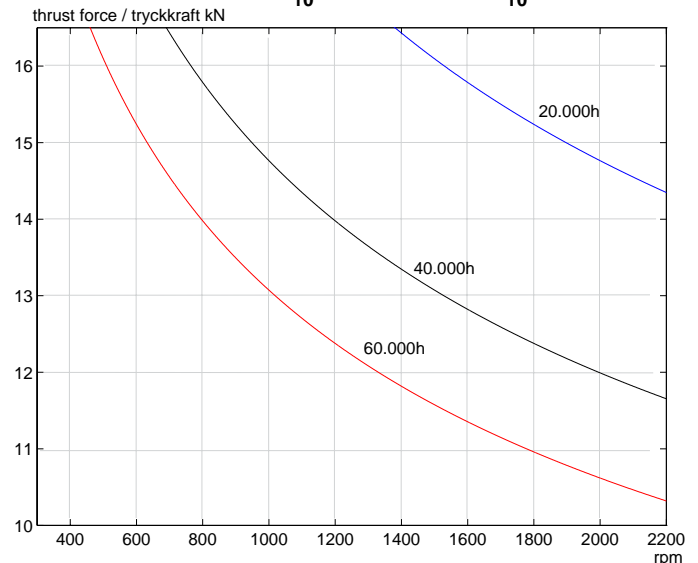

Max statiskt vridmoment (sträckgräns)	4175Nm
Max static torque (yield point)	3090 lbft
Max propelleraxelvarvtal	2200 rpm
Max propellershaft revolutions	
Max rekommenderad propellerkraft	16500 N
Max recommended prop. thrust	3700 lbf